



Digitized Automation for a Changing World

Delta Sensorless Vector Control Compact Drive VFD-EL Series



www.deltaww.com

Send Quote Requests to info@automatedpt.com
Call +1(800)985-6929 To Order or Order Online At Deltaacdrives.com



DELTA
Smarter. Greener. Together.

Features

▶ Standard Modbus Protocol

Standard Modbus protocol via RS-485

▶ Built-in EMC Filter (230V single-phase and 460V 3-phase)

The built-in EMC filter reduces electromagnetic interference and complies with the EN61800-3 standard

▶ Compact Design

Space saving and easy DIN rail mounting with optional DIN rail adapter (Built-in for Frame B)

▶ Optional Fieldbus Modules

Provide connection to a variety of networks, including PROFIBUS, DeviceNet and CANopen

▶ RFI Switch for IT Mains

Removable "Y" capacitor to use with IT mains supplies



▶ DC Bus Sharing

Multiple VFD-EL can be connected in parallel to share the regenerative braking energy. This prevents over-voltage and stabilizes DC bus voltage.

*This function is not supported by the 115V model.

▶ Complete Protection Functions

High precision current detection, full overload protection (oL, oL1 and oL2), overvoltage/overcurrent stall prevention, short-circuit protection, reset after fault, speed search function and motor overheat protection by PTC

▶ Power Range

Single-phase 115V series: 0.2~0.75kW (0.25~1 hp)
Single-phase 230V series: 0.2~2.2kW (0.25~3 hp)
3-phase 230V series: 0.2~3.7kW (0.25~5 hp)
3-phase 460V series: 0.4~3.7kW (0.50~5 hp)

▶ Side-by-side Installation (40°C)

High-efficiency cooling and flexible spacing



▶ Easy Maintenance

Removable cooling fan for easy maintenance



Applications

► Conveyor Belts

1. Multi-step speed application: provides multi-step speed settings to meet the needs of a conveyor belt
2. Side-by-side installation to save space
3. DC bus sharing: connects multiple drives in parallel to share the regenerative energy and prevent overvoltage



► Winders

Auto acceleration/deceleration function provides rapid start/stop of operation and increases productivity and efficiency

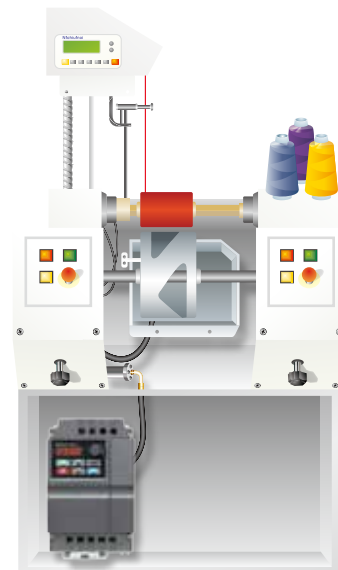

► Constant Pressure Control of Water Pumps

1. Built-in smart PID controller saves the cost of a specified external PID meter
2. Built-in auto detection of water suspension and auto power-on saves the cost of external PLC controller and relay
3. A wide range of input voltages are available, including single-phase 110V/230V and 3-phase 230V/460V, for various pump applications and different countries

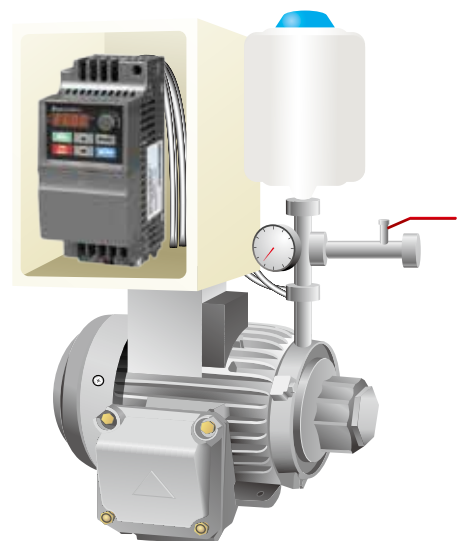

Standard Wiring Diagram

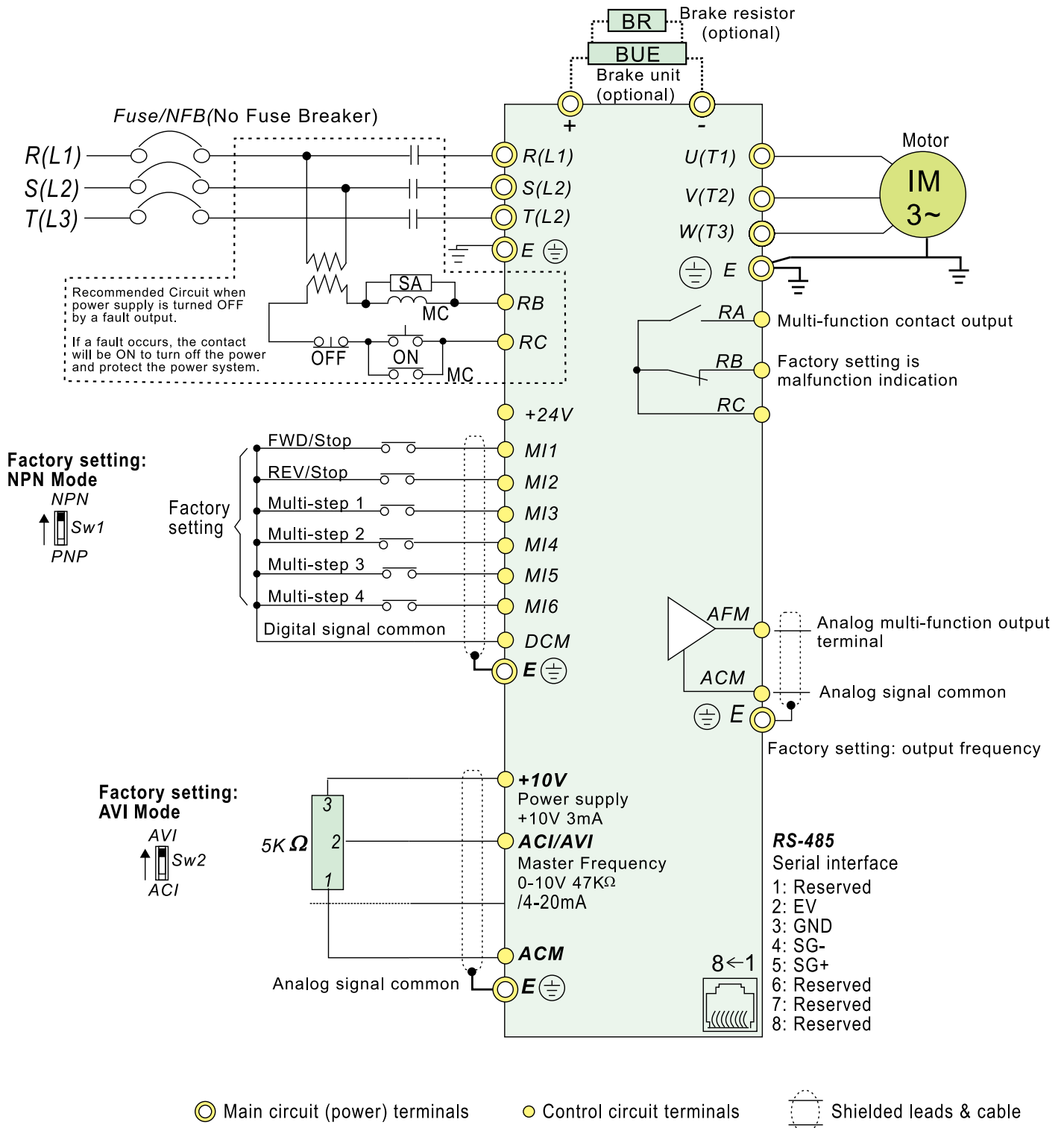

NOTE

It is recommended to install circuit breaker at the control terminal to protect the circuit from operation abnormality or sudden power outage.

The protection circuit uses the multi-function output terminal of the AC motor drive for connection. When an abnormal condition (closed contact) occurs, the external power supply is disconnected to protect the power system of the AC motor drive.

External Parts

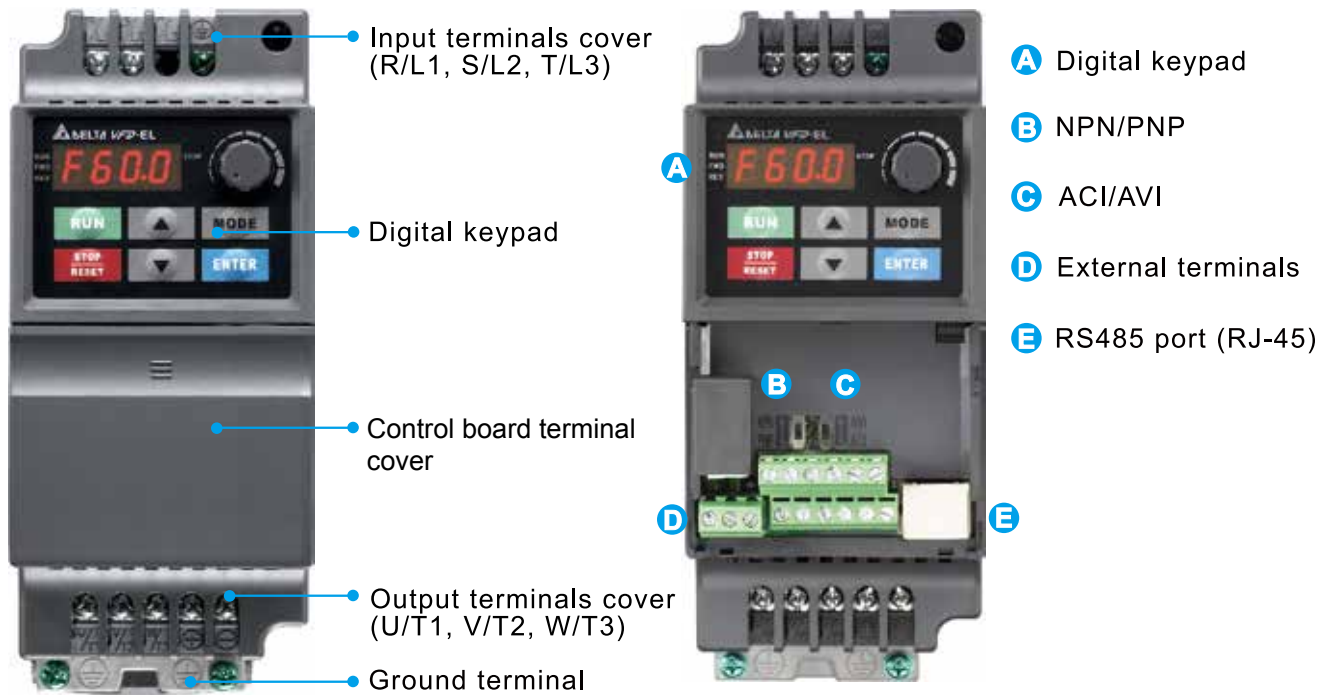

Control Terminals

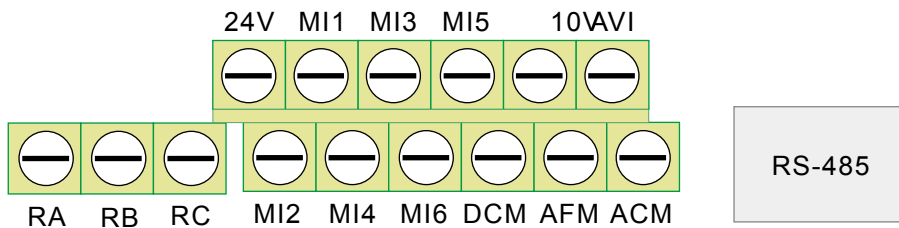

Model Explanation

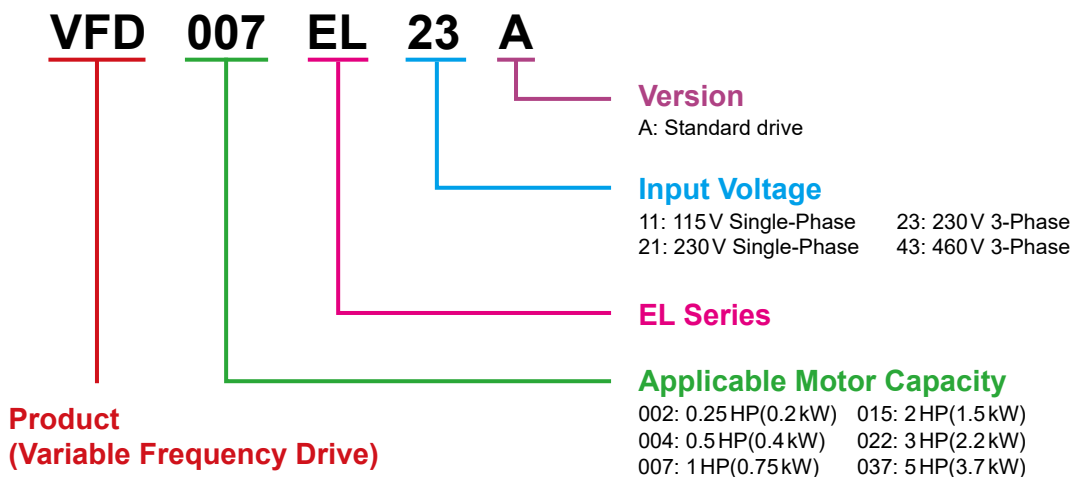

Application Fields

Conveyor and Transportation Machinery

- Conveyor belt
- Automatic door
- Roller door
- Small elevator
- Escalator
- X,Y-axis traveling crane

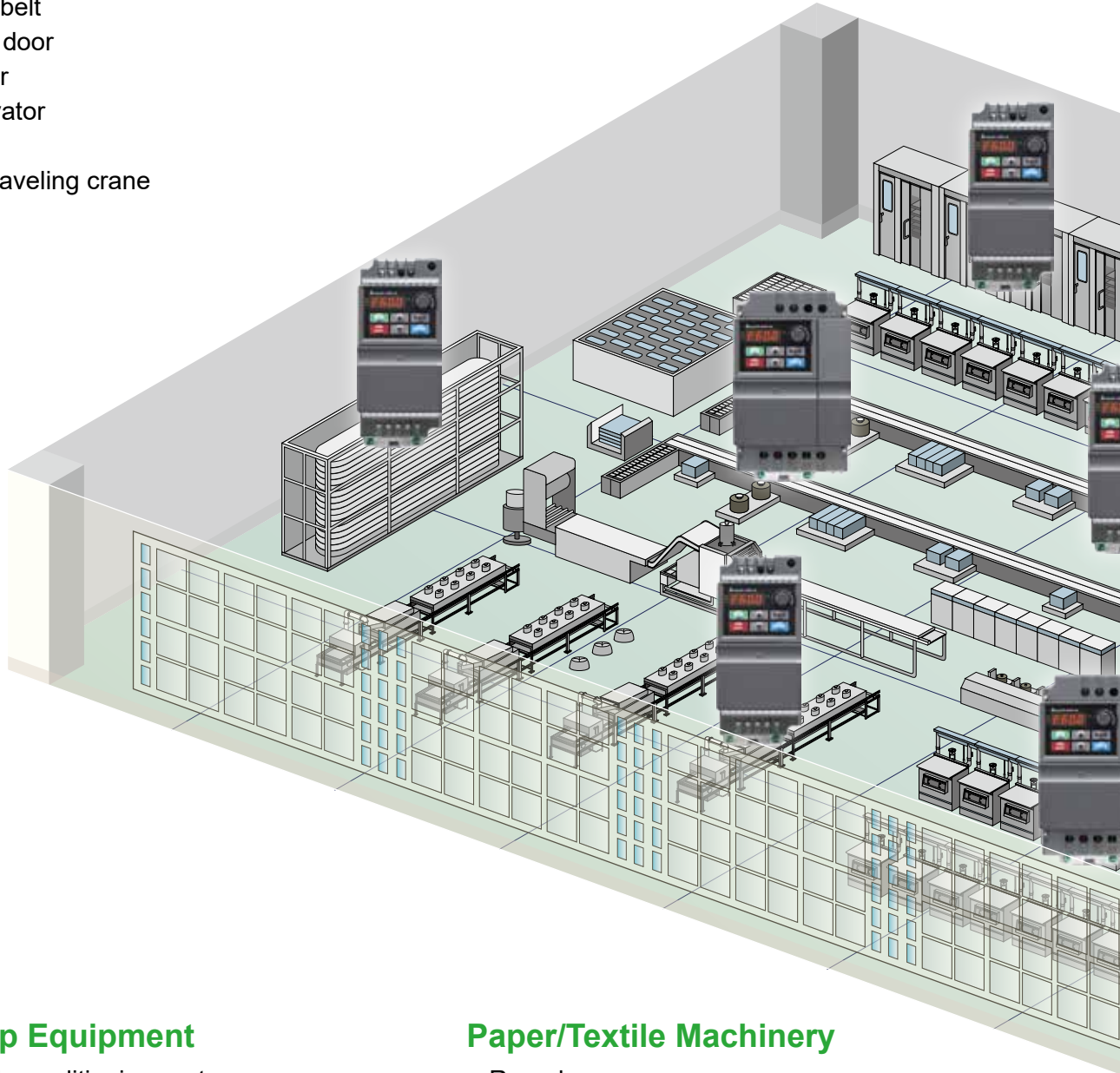

Fan/Pump Equipment

- Building air conditioning system
- Wastewater processing system
- Constant pressure water treatment system
- Water treatment pump
- Agricultural pump
- Temperature control of mid and larger oven
- Air compressor
- Heat exchange fan
- Building water dispenser system
- Dryer's windmill

Paper/Textile Machinery

- Round weaver
- Cross weaver
- Ribbon weaver
- Printing press
- Industrial sewing machine
- Knitting machine

Food Processing

- Dumpling making machine
- Food mixer
- Noodle making machine

Wood Working Machinery

- 4 side planer
- Wood carving machine
- Woodworking machine
- Simple cutting machine for wood working
- Spraying machine

Machine Tool/Metal Processing Machinery

- Grinding machine
- Drilling machine
- Small lathe
- Milling machine
- Injection molding (clamp)

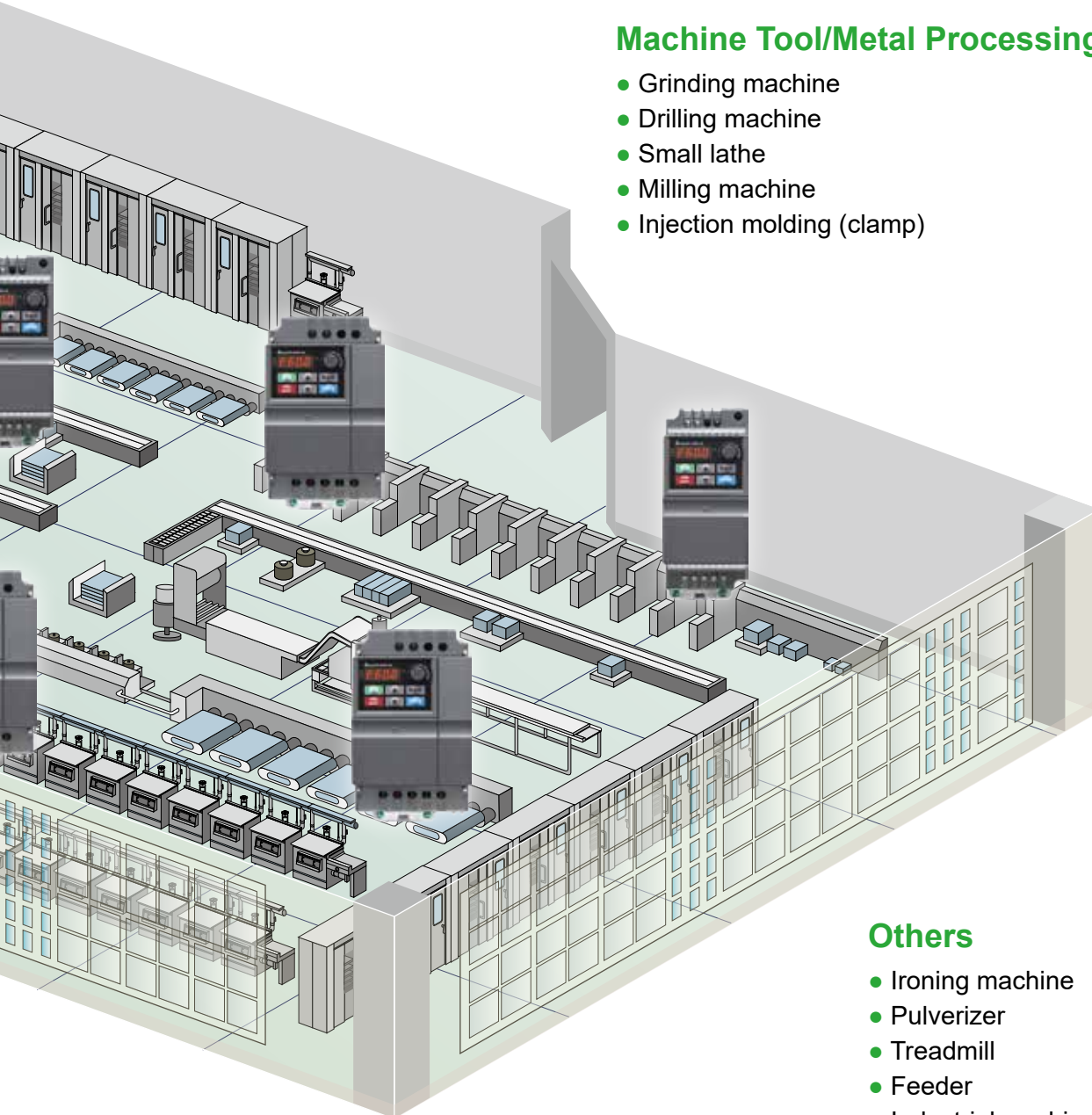

Others



- Ironing machine
- Pulverizer
- Treadmill
- Feeder
- Industrial washing machine
- Car washing machine
- Packing machine
- Centrifuge
- Liquid mixing machine

Specifications

| 115V | | 115V | | |
|-----------------------------------|-----------------------------|---|-----|------|
| Voltage Class | | 115V | | |
| Model Number VFD-___ EL | | 002 | 004 | 007 |
| Max. Applicable Motor Output (kW) | | 0.2 | 0.4 | 0.75 |
| Max. Applicable Motor Output (Hp) | | 0.25 | 0.5 | 1.0 |
| Output Rating | Rated Output Capacity (kVA) | 0.6 | 1.0 | 1.6 |
| | Rated Output Current (A) | 1.6 | 2.5 | 4.2 |
| | Maximum Output Voltage (V) | 3-phase proportional to twice the input voltage | | |
| | Output Frequency (Hz) | 0.1~599Hz | | |
| Carrier Frequency (kHz) | | 2~12 | | |
| Input Rating | Rated Input Current (A) | Single-phase | | |
| | | 6.4 | 9 | 18 |
| | Rated Voltage/Frequency | Single-phase 100~120V, 50/60Hz | | |
| | Voltage Tolerance | ±10% (90~132V) | | |
| Frequency Tolerance | | ±5% (47~63Hz) | | |
| Cooling Method | | Natural cooling | | |
| Weight (kg) | | 1.1 | 1.1 | 1.4 |

| 230V | | 230V | | | | | | |
|-----------------------------------|-----------------------------|---------------------------------------|---|--|-----|-------------|------|------|
| Voltage Class | | 230V | | | | | | |
| Model Number VFD-___ EL | | 002 | 004 | 007 | 015 | 022 | 037 | |
| Max. Applicable Motor Output (kW) | | 0.2 | 0.4 | 0.75 | 1.5 | 2.2 | 3.7 | |
| Max. Applicable Motor Output (Hp) | | 0.25 | 0.5 | 1.0 | 2.0 | 3.0 | 5.0 | |
| Output Rating | Rated Output Capacity (kVA) | 0.6 | 1.0 | 1.6 | 2.9 | 4.2 | 6.5 | |
| | Rated Output Current (A) | 1.6 | 2.5 | 4.2 | 7.5 | 11.0 | 17.0 | |
| | Maximum Output Voltage (V) | 3-phase proportional to input voltage | | | | | | |
| | Output Frequency (Hz) | 0.1~599Hz | | | | | | |
| Carrier Frequency (kHz) | | 2~12 | | | | | | |
| Input Rating | XXXE L21A | Rated Input Current (A) | 4.9 | 6.5 | 9.5 | 15.7 | 24 | -- |
| | | Rated Voltage/Frequency | Single-phase, 200~240V, 50/60Hz | | | | | |
| | XXXE L23A | Rated Input Current (A) | 1.9 | 2.7 | 4.9 | 9 | 15 | 20.6 |
| | | Rated Voltage/Frequency | Single-phase/3-phase, 200~240V, 50/60Hz | | | | | |
| Voltage Tolerance | | ±10% (180~264V) | | | | | | |
| Frequency Tolerance | | ±5% (47~63Hz) | | | | | | |
| Cooling Method | | Natural cooling | | Fan cooling (XXXEL21A) Natural cooling (XXXEL23A) | | Fan cooling | | |
| Weight (kg) | | 1.2 | 1.2 | 1.2 | 1.7 | 1.7 | 1.7 | |

| 460V | | 460V | | | | |
|-----------------------------------|-----------------------------|---------------------------------------|------|-------------|-----|-----|
| Voltage Class | | 460V | | | | |
| Model Number VFD-___ EL | | 004 | 007 | 015 | 022 | 037 |
| Max. Applicable Motor Output (kW) | | 0.4 | 0.75 | 1.5 | 2.2 | 3.7 |
| Max. Applicable Motor Output (hp) | | 0.5 | 1.0 | 2.0 | 3.0 | 5.0 |
| Output Rating | Rated Output Capacity (kVA) | 1.2 | 2.0 | 3.3 | 4.4 | 6.8 |
| | Rated Output Current (A) | 1.5 | 2.5 | 4.2 | 5.5 | 8.2 |
| | Maximum Output Voltage (V) | 3-phase proportional to input voltage | | | | |
| | Output Frequency (Hz) | 0.1~599 Hz | | | | |
| Carrier Frequency (kHz) | | 2~12 | | | | |
| Input Rating | Rated Input Current (A) | 3-phase | | | | |
| | | 1.8 | 3.2 | 4.3 | 7.1 | 9.0 |
| | Rated Voltage/Frequency | 3-phase, 380~480V, 50/60Hz | | | | |
| | Voltage Tolerance | ±10% (342~528V) | | | | |
| Frequency Tolerance | | ±5% (47~63Hz) | | | | |
| Cooling Method | | Natural cooling | | Fan cooling | | |
| Weight (kg) | | 1.2 | 1.2 | 1.2 | 1.7 | 1.7 |

| | | | |
|-----------------------------|--|---|---|
| Control Characteristics | Control System | | SPWM (Sinusoidal Pulse Width Modulation) control (V/F control) |
| | Frequency Setting Resolution | | 0.01 Hz |
| | Output Frequency Resolution | | 0.01 Hz |
| | Torque Characteristics | | Including the auto-torque/auto-slip compensation; starting torque can be 150 % at 5.0Hz |
| | Overload Endurance | | 150% of rated current for 1 minute |
| | Skip Frequency | | Three zones, setting range 0.1 ~ 599Hz |
| | Accel/Decel Time | | 0.1 to 600 seconds (2 Independent settings for Accel/Decel time) |
| | Stall Prevention Level | | Setting 20 to 250 % of rated current |
| | DC Braking | | Operation frequency 0.1 ~ 599Hz, output 0 ~ 100 % rated current Start time 0 ~ 60 seconds, stop time 0 ~ 60 seconds |
| | Regenerated Braking Torque | | Approx. 20% (up to 125 % possible with optional brake resistor) |
| | V/F Pattern | | Adjustable V/F pattern |
| Operating Characteristics | Frequency Setting | Keypad | Setting by ▲ ▼ |
| | | External Signal | Potentiometer 5k/0.5W, 0 to +10V _{DC} , 4 to 20mA, RS-485 interface; Multi-function Inputs 3 to 6 (15 steps, Jog, up/down) |
| | Operation Setting Signal | Keypad | Set by RUN and STOP |
| | | External Signal | 2 wires/3 wires (MI1, MI2, MI3), JOG operation, RS-485 serial interface (Modbus) |
| | Multi-function Input Signal | | Multi-step selection 0 to 15, Jog, accel / decel inhibit, 2 accel / decel switches, counter, external Base Block, ACI/AVI selections, driver reset, UP/DOWN key settings, NPN/PNP input selection |
| | Multi-function Output Indication | | AC drive operating, frequency attained, counter attained, zero speed, Base Block, fault indication, overheat alarm, emergency stop and status selections of input terminals |
| | Analog Output Signal | | Output frequency / current |
| Alarm Output Contact | | Contact will be ON when drive malfunctions (1 Form C/change-over contact or 1 open collector output) | |
| Operation Functions | | AVR, accel / decel S-Curve, overvoltage / overcurrent stall prevention, 5 fault records, reverse inhibition, momentary power loss restart, DC braking, auto torque / slip compensation, adjustable carrier frequency, output frequency limits, parameter lock / reset, PID control, external counter, MODBUS communication, abnormal reset, abnormal re-start, power-saving, fan control, sleep/wake frequency, 1st/2nd frequency source selections, 1st/2nd frequency source combination, NPN/PNP selection | |
| Protection Functions | | Over voltage, over current, under voltage, external fault, overload, ground fault, overheating, electronic thermal, IGBT short circuit, PTC | |
| Display Keypad | | 6-key, 7-segment LED with 4-digit, 4 status LEDs, master frequency, output frequency, output current, custom units, parameter values for setup and lock, faults, RUN, STOP, RESET, FWD/REV | |
| Built-in EMC Filter | | For 230V 1-phase and 460V 3-phase models | |
| Environmental Conditions | Enclosure Rating | | IP20 |
| | Pollution Degree | | 2 |
| | Installation Location | | Altitude 1,000 m or lower, keep from corrosive gasses, liquid and dust |
| | Ambient Temperature | | -10°C ~ 50°C (40°C for side-by-side mounting) non-condensing and not frozen |
| | Storage/ Transportation Temperature | | -20°C ~ 60°C |
| | Ambient Humidity | | Below 90 % RH (non-condensing) |
| | Vibration | | 9.80665 m/s ² (1G) less than 20Hz, 5.88 m/s (0.6 G) at 20 ~ 50 Hz |
| Certifications | |    | |

Dimensions

Frame A

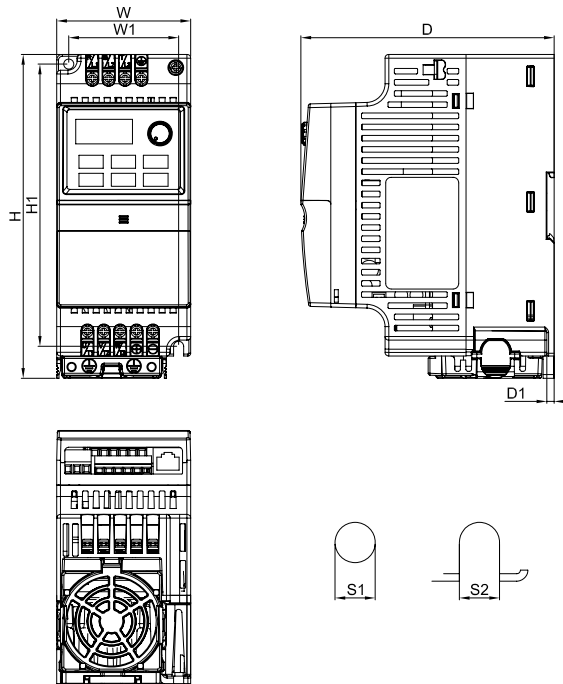

MODEL

- VFD002EL11A
- VFD002EL21A
- VFD002EL23A
- VFD004EL11A
- VFD004EL21A
- VFD004EL23A
- VDF004EL43A
- VFD007EL21A
- VDF007EL23A
- VDF007EL43A
- VDF015EL23A
- VDF015EL43A

Unit: mm[inch]

| Frame | | W | H | D | W1 | H1 | D1 | S1 | S2 |
|-------|------|------|-------|-------|------|-------|------|------|------|
| A | mm | 72.0 | 174.0 | 136.0 | 59.0 | 151.6 | 4.0 | 5.4 | 5.4 |
| | inch | 2.83 | 6.86 | 5.36 | 2.32 | 5.97 | 0.16 | 0.21 | 0.21 |

Frame B

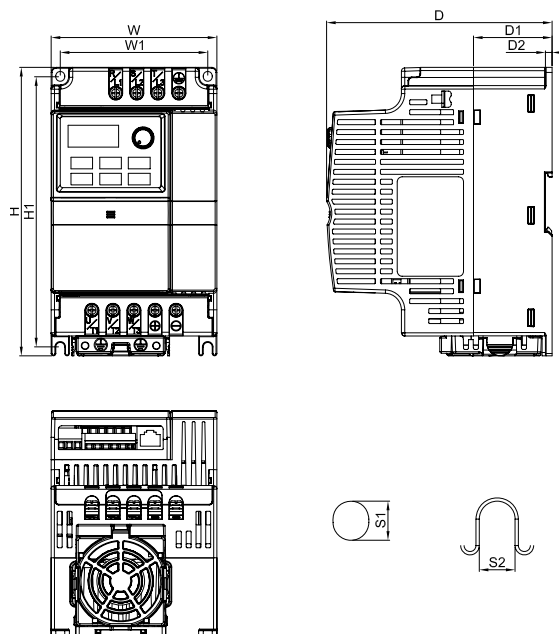

MODEL

- VFD007EL11A
- VFD015EL21A
- VFD022EL21A
- VDF022EL23A
- VFD022EL43A
- VDF037EL23A
- VDF037EL43A

Unit: mm[inch]

| Frame | | W | H | D | W1 | H1 | D1 | D2 | S1 | S2 |
|-------|------|-------|-------|-------|------|-------|------|------|------|------|
| B | mm | 100.0 | 174.0 | 136.0 | 89.0 | 162.9 | 47.4 | 4.0 | 5.9 | 5.4 |
| | inch | 3.94 | 6.85 | 5.36 | 3.50 | 6.42 | 1.87 | 0.16 | 0.23 | 0.21 |

Accessories

Fieldbus Modules



▪ **DeviceNet**
CME-DN01



▪ **PROFIBUS**
CME-PD01



▪ **CANopen**
CME-COP01

Others



▪ **Brake unit**
BUE-20015 BUE-40015
BUE-20037 BUE-40037



▪ **Communication keypad**
VFD-PU06



▪ **DIN Rail (Width 35mm)**
MKEL-DRA MKEL-DRB



▪ **Brake resistor**





▪ **Zero phase reactor**
RF220X00A



▪ **Grounding plate**
MKE-EP

Ordering Information

| Frame Size | Power Range | Models |
|---|---|--|
| Frame A  | 115V: 0.2 kW~0.4 kW 230V: 0.2 kW~1.5 kW 460V: 0.4 kW~1.5 kW | VFD002EL 11A / 21A / 23A VFD004EL 11A / 21A / 23A / 43A VFD007EL 21A / 23A / 43A VFD015EL 23A / 43A |
| Frame B  | 115V: 0.75 kW 230V: 1.5 kW~3.7 kW 460V: 2.2 kW~3.7 kW | VFD007EL11A VFD015EL 21A VFD022EL 21A / 23A / 43A VFD037EL 23A / 43A |



Industrial Automation Headquarters

Taiwan: Delta Electronics, Inc.

Taoyuan Technology Center
No.18, Xinglong Rd., Taoyuan District,
Taoyuan City 33068, Taiwan
TEL: +886-3-362-6301 / FAX: +886-3-371-6301

Asia

China: Delta Electronics (Shanghai) Co., Ltd.

No.182 Minyu Rd., Pudong Shanghai, P.R.C.
Post code : 201209
TEL: +86-21-6872-3988 / FAX: +86-21-6872-3996
Customer Service: 400-820-9595

Japan: Delta Electronics (Japan), Inc.

Industrial Automation Sales Department
2-1-14 Shibadaimon, Minato-ku
Tokyo, Japan 105-0012
TEL: +81-3-5733-1155 / FAX: +81-3-5733-1255

Korea: Delta Electronics (Korea), Inc.

1511, 219, Gasan Digital 1-Ro., Geumcheon-gu,
Seoul, 08501 South Korea
TEL: +82-2-515-5305 / FAX: +82-2-515-5302

Singapore: Delta Energy Systems (Singapore) Pte Ltd.

4 Kaki Bukit Avenue 1, #05-04, Singapore 417939
TEL: +65-6747-5155 / FAX: +65-6744-9228

India: Delta Electronics (India) Pvt. Ltd.

Plot No.43, Sector 35, HSIIDC Gurgaon,
PIN 122001, Haryana, India
TEL: +91-124-4874900 / FAX: +91-124-4874945

Thailand: Delta Electronics (Thailand) PCL.

909 Soi 9, Moo 4, Bangpoo Industrial Estate (E.P.Z),
Pattana 1 Rd., T.Phraksa, A.Muang,
Samutprakarn 10280, Thailand
TEL: +66-2709-2800 / FAX: +66-2709-2827

Australia: Delta Electronics (Australia) Pty Ltd.

Unit 20-21/45 Normanby Rd., Notting Hill Vic 3168, Australia
TEL: +61-3-9543-3720

Americas

USA: Delta Electronics (Americas) Ltd.

5101 Davis Drive, Research Triangle Park, NC 27709, U.S.A.
TEL: +1-919-767-3813 / FAX: +1-919-767-3969

Brazil: Delta Electronics Brazil

Rua Itapeva, 26 - 3º, andar Edifício Itapeva,
One - Bela Vista 01332-000 - São Paulo - SP - Brazil
TEL: +55-12-3932-2300 / FAX: +55-12-3932-237

Mexico: Delta Electronics International Mexico S.A. de C.V.

Gustavo Baz No. 309 Edificio E PB 103
Colonia La Loma, CP 54060
Tlalnepantla, Estado de México
TEL: +52-55-3603-9200

EMEA

EMEA Headquarters: Delta Electronics (Netherlands) B.V.

Sales: Sales.IA.EMEA@deltaww.com
Marketing: Marketing.IA.EMEA@deltaww.com
Technical Support: iatechnicalsupport@deltaww.com
Customer Support: Customer-Support@deltaww.com
Service: Service.IA.emea@deltaww.com
TEL: +31(0)40 800 3900

BENELUX: Delta Electronics (Netherlands) B.V.

Automotive Campus 260, 5708 JZ Helmond, The Netherlands
Mail: Sales.IA.Benelux@deltaww.com
TEL: +31(0)40 800 3900

DACH: Delta Electronics (Netherlands) B.V.

Coesterweg 45, D-59494 Soest, Germany
Mail: Sales.IA.DACH@deltaww.com
TEL: +49(0)2921 987 0

France: Delta Electronics (France) S.A.

ZI du bois Challand 2, 15 rue des Pyrénées,
Lisses, 91090 Evry Cedex, France
Mail: Sales.IA.FR@deltaww.com
TEL: +33(0)1 69 77 82 60

Iberia: Delta Electronics Solutions (Spain) S.L.U

Ctra. De Villaverde a Vallecas, 265 1º Dcha Ed.
Hormigueras – P.I. de Vallecas 28031 Madrid
TEL: +34(0)91 223 74 20

Carrer Llacuna 166, 08018 Barcelona, Spain

Mail: Sales.IA.Iberia@deltaww.com

Italy: Delta Electronics (Italy) S.r.l.

Via Meda 2-22060 Novedrate(CO)
Piazza Grazioli 18 00186 Roma Italy
Mail: Sales.IA.Italy@deltaww.com
TEL: +39 039 8900365

Russia: Delta Energy System LLC

Vereyskaya Plaza II, office 112 Vereyskaya str.
17 121357 Moscow Russia
Mail: Sales.IA.RU@deltaww.com
TEL: +7 495 644 3240

Turkey: Delta Greentech Elektronik San. Ltd. Sti. (Turkey)

Şerifali Mah. Hendem Cad. Kule Sok. No:16-A
34775 Ümraniye – İstanbul
Mail: Sales.IA.Turkey@deltaww.com
TEL: + 90 216 499 9910

MEA: Eltek Dubai (Eltek MEA DMCC)

OFFICE 2504, 25th Floor, Saba Tower 1,
Jumeirah Lakes Towers, Dubai, UAE
Mail: Sales.IA.MEA@deltaww.com
TEL: +971(0)4 2690148